

PARÇA KODU PART CODE	PARÇA ADI PART NAME	s ÖLÇÜSÜ (KALINLIK) s MEASURE (THICKNESS)	Malzeme Material	Kaplama / Coating		
				SN	AG	Nİ
TE 2363 DP	UZUN ERKEK FİŞ 7.7 =DP=	-----	(CuZn30) Pirinç / Brass	-	-	-
TE 2363 RP	UZUN ERKEK FİŞ 7.7 =RP=	-----	(CuZn30) Pirinç / Brass	-	-	-
TE 2363 RPK	UZUN ERKEK FİŞ 7.7 =RPK=	-----	(CuZn30) Pirinç / Brass	+	-	-

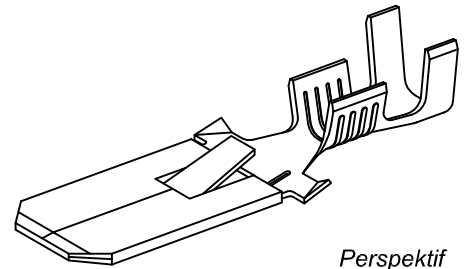

Perspektif
Perspective

Kalıp çıkış yönü
Mold output direction ← → Makara açılım yönü
Reel opening direction

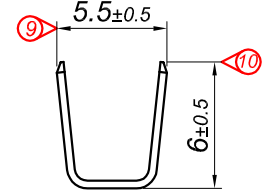
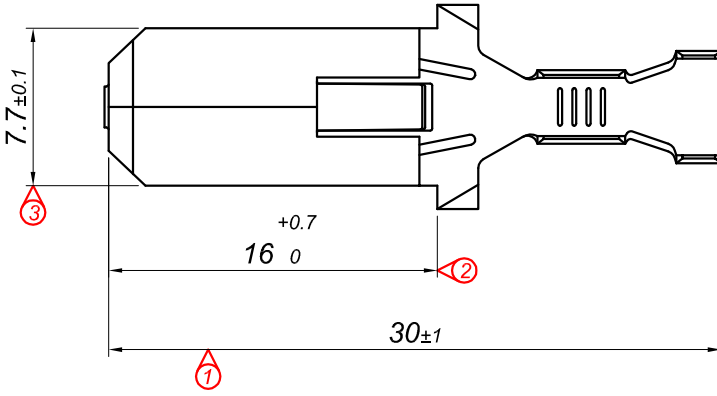
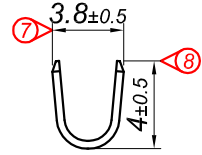
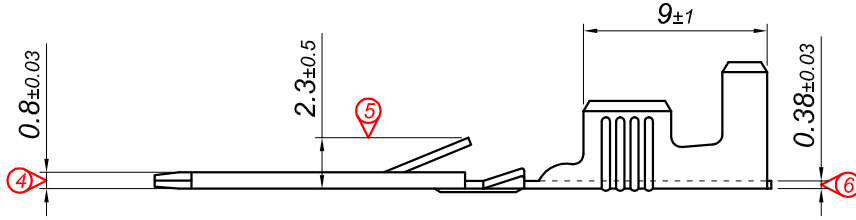
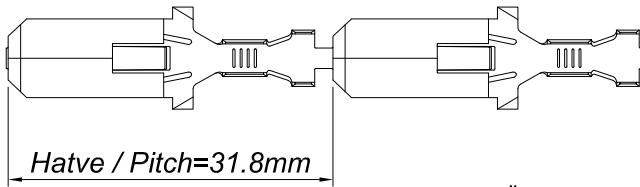

Ölçek
Scale : 1.5 / 1

Kablo Kesiti
Wire Section : 1 - 2.50 mm²

Resim üzerinden ölçü almayınız
do not measure on drawing

Tarih / Date	14.04.2013	İmza / Signature	Ölçek / Scale			
Çizen / Desing	M.Yağcı		3 / 1			
Onay / Approval	S.Gölcük		No		Değişiklik / Revision	Tarih/Date
	Parça Adı: Part Name	UZUN ERKEK FİŞ 7.7			Parça Kodu: Part Code	TE 2363